

Operation Manual (EN)
Translation of the german original manual

Diaphragm pumps in casing 4 - headed

Models:

- ▶ MPC 155 Z
- ▶ MPC 105 T

- ▶ MPC 105 T iQ
- ▶ MPC 105 T iQ-P



Gardner Denver Thomas GmbH

Am Vogelherd 20

98693 Ilmenau

Germany

T +49 3677 604 0

F +49 3677 604 131

welch.emea@gardnerdenver.com

www.welchvacuum.com

Customer Support +49 3677 604 0

We are constantly working on the further development of all our product types.

Reprinting or reproduction of this manual, including extracts, is not allowed without the prior written permission of Co. Gardner Denver Thomas GmbH.

All rights under the copyright laws are expressly reserved by Co. Gardner Denver Thomas GmbH.

We reserve the right to make changes and amendments.

Contents

1	Important Information	4
1.1	General Information	4
1.2	Target Groups	4
1.3	Intended Use.....	4
1.4	Use for an Unauthorized Purpose	4
1.5	Safety Devices	5
1.6	Meaning of the Warning notes.....	5
1.7	Product Standards, Safety Regulations.....	5
2	Basic Safety Instructions	6
2.1	General Information	6
2.2	Electricity.....	6
2.3	Mechanical Systems	6
2.4	Hazardous Substances.....	7
2.5	High Temperatures	7
2.6	Dimensioning the fine-wire fuse.....	7
3	Description	8
3.1	Design and Function	8
3.2	Areas of Application	8
3.3	Pump head circuitry	9
3.4	Materials of the medium-affecting pump parts.....	9
3.5	Scope of Delivery	9
3.6	Accessories (optional).....	9
4	Technical Data	11
4.1	Dimensional drawing.....	11
4.2	Intake Pressure / Pumping Speed – Diagram	11
4.3	Device data	12
5	Installation and Operation	13
5.1	Unpacking	13
5.2	Setting up, Connecting, Operating.....	13
5.3	Storage.....	14
5.4	Scrap Disposal	14
6	Maintenance and Servicing	15
6.1	General Requirements.....	15
6.2	Maintenance Performed by the User	15
6.2.1	Disassembly.....	16
6.2.2	Assembly.....	16
6.2.3	Test	17
6.3	Maintenance by the Manufacturer	17
6.4	Damage Report.....	17
7	Troubleshooting	18
8	Spare Parts Overview	19
8.1	Service kit.....	19
8.2	Spare parts view MPC 155 Z	20
8.3	Spare parts view MPC 105 T	21
8.3.1	Spare parts list MPC 155 Z, MPC 105 T	22
8.4	Spare parts view MPC 105 T iQ-P, MPC 105 T iQ (24V).....	23
8.4.1	Spare parts list MPC 105 T iQ-P, MPC 105 T iQ.....	24

EC Declaration of Conformity

Important Information

1 Important Information

1.1 General Information

The Diaphragm Pumps conform to the following directives:

2006 / 42 / EC	Machinery Directive
2014 / 30 / EU	Electromagnetic Compatibility Directive

The CE sign is located on the rating plate. Observe the binding national and local regulations when fitting the pump into installations.

Our products are sold worldwide and can therefore be equipped with the typical national plugs and for the various voltages. You will find more information about the available pump designs on our web page in the internet.

1.2 Target Groups

This Operating Manual is intended for the personnel planning, operating and maintaining Diaphragm Pumps.

This group of people includes:

- Designers and fitters of vacuum apparatus,
- Employees working on commercial laboratory and industrial vacuum technology applications and
- Service personnel for diaphragm pumps

The personnel operating and maintaining the diaphragm pumps must have the technical competence required to perform the work that has to be done. The user must authorize the operating personnel to do the work that has to be done. The personnel must have read and understood the complete Operating Manual before using the diaphragm pumps. The Operating Manual must be kept at the place of use and be available to the personnel when required.

1.3 Intended Use

- The layout of the diaphragm pump must be appropriate for the conditions of use. The user bears the sole responsibility for this.
- The diaphragm pump may only be operated under the conditions stated
 - in the "Technical Data" section,
 - on the type plate, and
 - in the technical specification for the order concerned.
- Diaphragm pumps are approved for extracting, pumping and compressing gases and vapours. If these gases and vapours are toxic or explosive, then the user must observe the currently valid safety regulations for this application. Special types of diaphragm pumps are available for aggressive and explosive gas mixtures.

1.4 Use for an Unauthorized Purpose

It is forbidden to use the pump for applications deviating from the technical data stated on the type plate or the conditions stated in the supply contract, or to operate it with missing or defective protective devices.

1.5 Safety Devices

Measures such as the following are for the safety of the operating personnel:

- electrical connection with a protective conductor (operating mode S1)
- Main switch
- Device fuse
- "Hot Surface" label on the pump body - warning notice 

The diaphragm pump must not be operated without these elements.

1.6 Meaning of the Warning notes

Take note of the warning notices. They are in the following box:

	CAUTION ! / WARNING !
Hazard which may lead to serious injuries or material damage.	

1.7 Product Standards, Safety Regulations

The Diaphragm Pumps meet the following product standards:

DIN EN ISO 12100:2011-03	Safety of machinery - General principles for design - Risk assessment and risk reduction
DIN EN ISO 13857:2008-06	Safety of machinery - Safety distances to prevent hazard zones being reached by upper and lower limbs
DIN EN 1012-2:2011-12	Compressors and vacuum pumps - Safety requirements - Part 2: Vacuum pumps
DIN EN ISO 2151:2009-01	Acoustics - Noise test code for compressors and vacuum pumps - Engineering method (grade 2)
DIN EN 60204-1:2014-10	Safety of machinery - Electrical equipment of machines - Part 1: General requirements
DIN EN 61000-6-2:2011-06 DIN EN 61000-6-4:2011-09	Electromagnetic compatibility (EMC) - Part 6-2: Generic standards - Immunity for industrial environments Part 6-4: Generic standards - Emission standard for industrial environments
DIN EN 61010-1/A1:2015-04	Safety requirements for electrical equipment for measurement, control and laboratory use - Part 1: General requirements
DIN EN 50110-1:2014-02	Operation of electrical installations
Directive 2012/19/EU	Electrical and electronics - old devices (WEEE)
Directive 2011/65/EU	Dangerous materials in electrical and electronics devices (RoHS II)
China - RoHS II	Environment protection law - China 2016-01

The following additional safety regulations apply in the FR Germany:

BGV A3	Electrical equipment and operating materials
VBG 5	Power-driven machines
BGR 120	Guidelines for laboratories
BGI 798	Hazard assessment in the laboratory
BGG 919 (VBG 16)	Accident prevention regulations for "compressors"
BGR 189 (BGR 195;192;197)	Use of protective working clothes

Observe the standards and regulations applying in your country when you use the diaphragm pumps.

Basic Safety Instructions

2 Basic Safety Instructions

2.1 General Information

Warning notices must be observed. Disregarding them may lead to damage to health and property.

The diaphragm pumps must be operated by personnel who can detect impending dangers and take action to prevent them from materialising.

The manufacturer or authorized authorised workshops will only service or maintain the diaphragm pump if it is accompanied by a fully completed damage report. Precise information about the contamination (also negative information if necessary) and thorough cleaning of the diaphragm pump are legally binding parts of the contract.

Contaminated diaphragm pumps and their individual parts must be disposed of in accordance with the legal regulations.

The local regulations apply in foreign countries.

2.2 Electricity

The diaphragm pumps of operation mode S1 are supplied. When the location of operation mode S1 devices is changed, please note that the testing must be repeated in accordance with DIN EN 0105, DIN EN 0702 and BGV A2. The local regulations apply in foreign countries. Please note the following when connecting the plug to the electrical power supply system:

- The electrical power supply system must have a protective connector according to DIN VDE 0100-410 (IEC 60364-4-41).
- The protective connector must not have any breaks.
- The connecting cable must not be damaged.

2.3 Mechanical Systems

Improper use can lead to injuries or material damage. Observe the following instructions:

- Only operate the diaphragm pumps with hoses of the specified dimensions.
- The maximum permissible pressure of 1 bar at the suction connection must not be exceeded.
- Hazardous substances must be separated out as far as this is technically possible before they reach the pump.
- External mechanical stresses and vibrations must not be transmitted to the pump. Only use flexible laboratory hoses for connecting diaphragm pumps.
- The overpressure generated at the pressure port must not exceed 1 bar.
- The pump must not be used to suck up fluids. Lay the exhaust pipe so that it slopes downwards, so allowing condensate to flow out of the pump. Collect the condensate and dispose of it in an environmentally compatible manner.
- Prevent dyes exuding.
- Maintain near the venting slots a space of at least 20 mm between the pump and adjacent parts in order to enable the pump to cool.

	CAUTION !
Solid particles in the pumping medium impair the pumping action and can lead to damage. Prevent solid particles penetrating into the pump.	

2.4 Hazardous Substances

The operating company bears the responsibility for the use of the diaphragm pump. Hazardous substances in the gases to be pumped can cause personal injuries and property damage. Pay attention to the warning notices for handling hazardous substances. The local regulations apply in foreign countries.

Combustible Gases

Examine before switching on whether that can form gas combustible gas/air mixtures which can be promoted! Consider the regulations of the guideline 1999/92/EC.

Explosive gases

The diaphragm pumps are not certified according to ATEX guidelines 2014/34/EU.

Aggressive gases

Extracting aggressive gases is not permitted.

Poisonous gases

Use a separator when pumping poisonous or harmful gases. Prevent such substances from leaking out of the appliance or pump. Treat these substances according to the applicable environmental protection regulations.

Test the strength and leak-tightness of the connecting lines and the connected apparatus. Prevent environmental poisons, e.g. mercury, getting into the diaphragm pumps.

Fulfil the requirements, for example:

- German Hazardous Substances Regulation (GefStoffV) of 01. December 2010
- Regulations 2016/1179/EU
(classification, packaging and identification of hazardous substances),
- Manufacturer's safety data sheets on hazardous substances.

2.5 High Temperatures

The diaphragm pump may heat up as a result of the temperature of the gas being pumped and through compression heat. Prevent the following maximum permissible temperatures from being exceeded.

- + 40 °C for the environment, and
- + 60 °C for the gas to be pumped.

The motor for single phase alternating current is protected against overload by a fine-wire fuse.

2.6 Dimensioning the fine-wire fuse

Pumps	Fine-wire fuse - Type	Order no.
- MPC 105 T iQ - MPC 105 T iQ-P	T 6.3 A	825372

Description

3 Description

3.1 Design and Function

Types	MPC 155 Z	MPC 105 T	MPC 105 T iQ	MPC 105 T iQ-P	
Order no.	412642	412443-02	412443-17	412443-15	
Legend					
1					Intake connection
2					Exhaust connection
3					Non-heating apparatus
4					Hollow plug (power pack)
5					ON/OFF
6					Control input
7					Potentiometer
Electrical connection via:	integrated power pack with Inlet connector (3)	external power pack via hollow plug (4)	integrated power pack with Inlet connector (3)		
Input voltage 90 – 260V, 50/60Hz					
Pump rotational speed and suction capacity may be controlled using:	-		External input (6)	Potentiometer (7)	
Device fuse	in the plug (3) , in the integrated drawer	automatic via an external power pack	in the plug (3) , in the integrated drawer		
Improvement of water vapor compatibility is possible, via:	a gas ballast valve on the front page		integrated heating of the pump heads		
Design	<p>The diaphragm pump consists of a pump body, a drive motor and a casing. The pump body consists of an eccentric, four connecting rod and four pump heads. Each pump head contains a diaphragm and two work valves. The pump heads are arranged in 180° opposite each other. The pump heads are driven via the motor and the eccentric with a connecting rod. The intake connection (1) and the exhaust connection (2) are located directly on the pump head and are designed as hose nozzle DN8 for an inside hose diameter of 8 mm.</p>				
Function	<p>Motor, eccentric shaft and connecting rod set the diaphragms in stroke movement. This changes the size of the space between the diaphragms and pump head (pump chamber). Increasing the size of the pump chamber opens the inlet valve while the outlet valve is closed (gases are sucked in). Decreasing the size of the pump chamber switches the valves over and ejects the gas through the exhaust outlet. The valves are actuated by the gas being pumped. A large proportion of condensate in the diaphragm pump minimizes the suction performance and the ultimate pressure that can be achieved.</p>				

3.2 Areas of Application

The Diaphragm pumps are intended for:

- Pumping and compressing neutral and aggressive gases and vapours.
- Generating a vacuum down to an ultimate pressure 2 mbar.
- Use in physical and chemical laboratories in trade and industry.
- Use for vacuum filtration, vacuum distillation and vacuum drying, and other vacuum technology applications.
- These can also be used in stripped down form for OEM applications (for example without a casing).

3.3 Pump head circuitry

Z	T	Legend:	
		Z -	Diaphragm pump – two stage Three pump heads are in parallel, the fourth in series.
		T -	Diaphragm pump – three stage Two pump heads are in parallel, the other two in series.
		IN -	Intake
		EX -	Exhaust
		S -	intake side
D -	exhaust side		

3.4 Materials of the medium-affecting pump parts

Component	Material <i>Chemical model, resistant to aggressive gases</i>
Seal	EPDM
Screw fitting / Connecting element	PVDF, PP
Valve	PEEK
Formed diaphragm	Elastomer + PTFE layer
Vacuum hose	PTFE
Connection head / Pump head	PTFE with carbon-fibre reinforcing ^{*)}

^{*)} electrically conductive (with manufacturer's certificate of electrical conductivity)
 Material resistance to aggressive media see: Publisher Hoppenstedt Publishing (18. September 2007)



3.5 Scope of Delivery

The scope of delivery is specified in the supply contract.

3.6 Accessories (optional)

Figure	Designation / Usage	Order no.
	Vacuum Control-Box VCB 521 cv for measuring and regulation of vacuum	600053
	Operating software "WELCH-Control 521" on CD with Dual-Data Cable to connect to the PC	620637-01

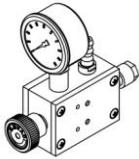
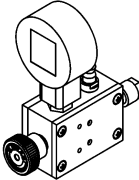
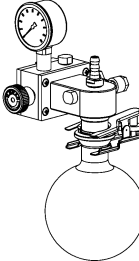
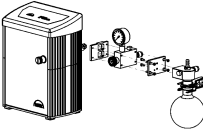
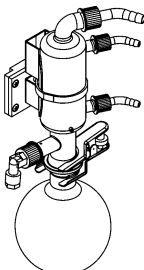
Description

Figure	Designation / Usage	Order no.
	<p>Vacuum regulator with dial gauge (analog) Type: DBR – P</p>	700459
	<p>Vacuum regulator with dial gauge (digital) Type: DBR – P</p> <p>With the help of this dosing block it is possible to regulate the final pressure of the pump. You can see the actual pressure at the dial gauge (manometer).</p> <p>For mounting of diaphragm pump. Mounting: clamping connection over nut of the side profiles</p>	700459-01
	<p>Vacuum regulator with dial gauge (analog) + Separator Type: DBR – PS</p> <p>With the help of this dosing block it is possible to regulate the final pressure of the pump. You can see the actual pressure at the dial gauge (manometer).</p>	700461
	<p>For mounting of diaphragm pump. Mounting: clamping connection over nut of the side profiles</p>	
	<p>Set of Extension: Emission condenser 500 ml</p> <p>For mounting of diaphragm pump. Mounting: clamping connection over nut of the side profiles</p>	700462
	<p>Mains connection cable IEC with plug type 12 (CH)</p> <p>for MPC ... in 230 V</p>	825877
	<p>Vacuum hose rubber, 18 / 8x5 mm</p> <p>1.5 m</p>	828310-4

4 Technical Data

4.1 Dimensional drawing

The main dimensions are identical for all pump types stated here.

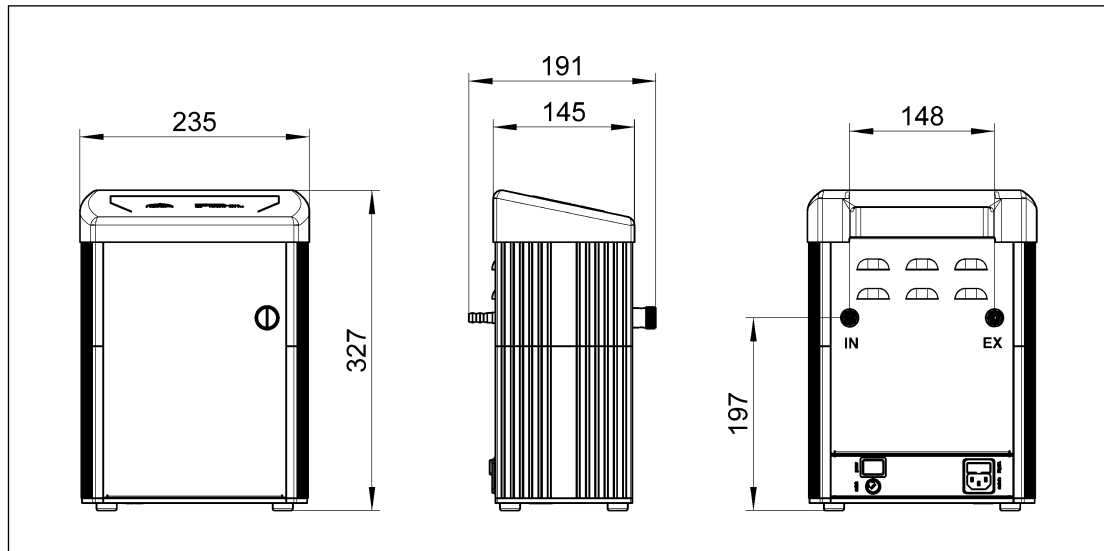

Fig. 1 Dimensions (MPC 105 T)

4.2 Intake Pressure / Pumping Speed – Diagram

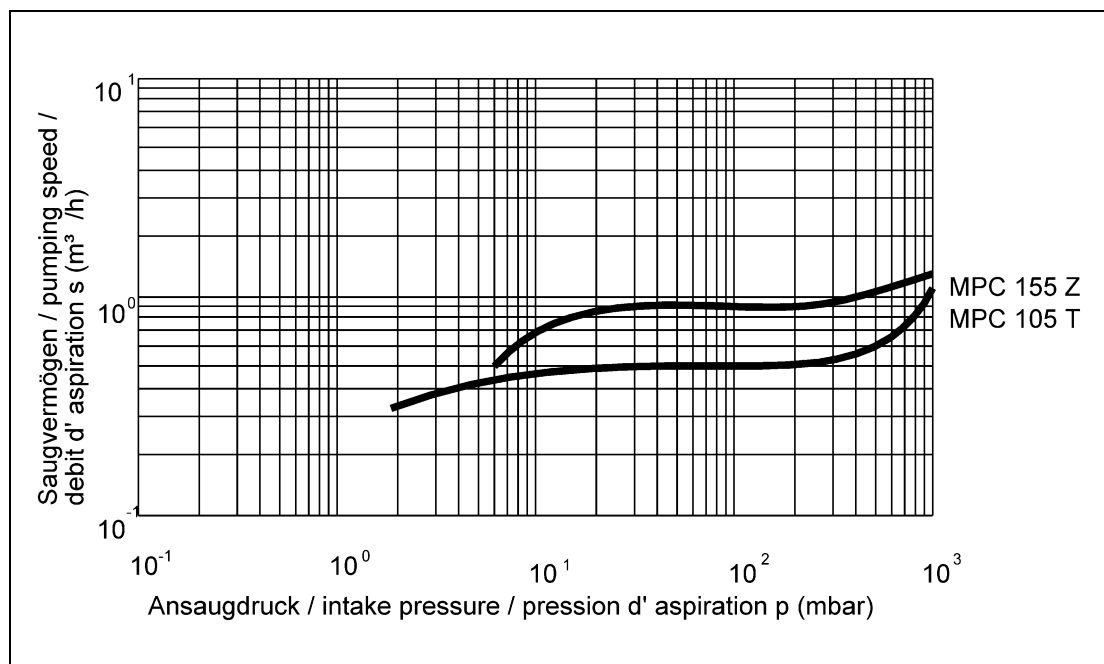

Fig. 2 Intake Pressure / Pumping Speed – Diagram

Technical Data

4.3 Device data

Parameter	Unit	MPC 155 Z	MPC 105 T	MPC 105 T iQ	MPC 105 T iQ-P
		<i>two-stage</i>	<i>three-stage</i>		
Pumping speed 50/60 Hz DIN 28432	m ³ / h	1,4	1.2	0 - 1.2	
	l / min	23	20	0 - 20	
Ultimate pressure	mbar	5	2		
Max. inlet pressure	bar	1			
Max. outlet pressure		unpressurised			
Intake- / Exhaust connection	-	Hose nozzle DN 8 for hose inside diameter 8 mm			
Ambient temperature	°C	+ 10 to + 40			
Max. Operating gas temperature		+ 60			
Bearing	-	maintenance-free			
Reference surface sound pressure level DIN EN ISO 2151	dB (A)	< 45			
Voltage, Frequency	V, Hz	24 V DC			
		90...260 V AC, 50/60 Hz			
		power pack integrated	power pack external	power pack integrated	
Rated current	A	5.6			
Rotational speed	min ⁻¹	1350		1700	
Control voltage	V DC	-	0 - 10		
			Input external Flange bushing Type 710 4 pole	Potentio- meter on the top of the unit	
Operating mode	-	S 1			
Type of protection DIN EN 60529		IP 44			
Motor / Class of insulation DIN EN 600034-1		BLDC / F (160°C)			
Weight	kg	7.0	6.5	7.0	
Dimensions (W/D/H) (without connections)	mm	235 / 145 / 327			
Order numbers	-	412642	412443-02	412443-17	412443-15

The information presented in this material is based on technical data and test results of nominal units. It is believed to be accurate and reliable and is offered as an aid to help in the selection of products. It is the responsibility of the user to determine the suitability of the product for the intended use and the user assumes all risk and liability whatsoever in connection therewith. Gardner Denver Thomas GmbH does not warrant, guarantee or assume any obligation or liability in connection with this information.

5 Installation and Operation

5.1 Unpacking

Carefully unpack the diaphragm pump.

Check the pump for:

- Transport damage,
- Conformity with the specifications of the supply contract (type, electrical supply data),
- Completeness of the delivery.

Please inform us without delay if there are discrepancies between the delivery and the contractually agreed scope of delivery, or if damage is detected.



Please take note of the general terms of business of the manufacturing firm.

In case of a claim under warranty, the device must be returned in packaging that is suitable for protecting it during transport.

5.2 Setting up, Connecting, Operating

	CAUTION!
Observe the basic safety instructions when using the pump.	

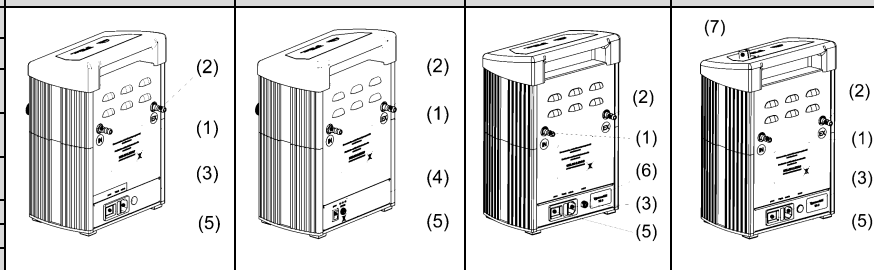
Procedure: (see also overview chapter 3.1)

Types	MPC 155 Z	MPC 105 T	MPC 105 T iQ	MPC 105 T iQ-P
Order No.	412642	412443-02	412443-17	412443-15
Legend:				
1 Intake connection				
2 Exhaust connection				
3 Non-heating apparatus				
4 Hollow plug (power pack)				
5 ON/OFF				
6 Control input				
7 Potentiometer				
<p>- Set the diaphragm pump on a flat and horizontal surface.</p>				
<p>- Take the two identically constructed hose nozzles (C) (complete with O-ring) out of the bag (B) fastened to the diaphragm pump for supply.</p> <p>- Screw the hose nozzles as intake - (1) and/or exhaust connection (2) into the thread seats (A) planned for it, see figures.</p> <div style="display: flex; justify-content: space-around; align-items: center;"> <div style="text-align: center;"> <p><i>as-delivered condition:</i></p>  <p>(A) (B) (C)</p> </div> <div style="text-align: center;"> <p><i>after the assembly:</i></p>  <p>(1) (2)</p> </div> </div>				
<p>- Connect the NW 8 vacuum connector to the intake connection (1).</p>				
<p>- The diaphragm pump is switched on and off at the switch (5).</p>				

Installation and Operation

5.3 Storage

The pumps are to be stored in a low-dust, interior room within the temperature range from + 5 to + 40 °C and at a relative air humidity < 90%.

Leave the protective elements on the intake and exhaust ports. Another equally good protection may be used. The interior of the pump heads must be dry and free of condensates.

The interior of the pump heads must be dry and free of condensates.

5.4 Scrap Disposal

	<p style="text-align: right;">CAUTION !</p>
<p>The Diaphragm pumps must be disposed of in accordance with the 2012/19/EU guideline and the specific national regulations. Contaminated diaphragm pumps must be decontaminated according to the laws.</p>	

6 Maintenance and Servicing

6.1 General Requirements

- Check the pump daily for unusual running noises and heat building up on the surface of the pump.
- We recommend changing the diaphragm after 10,000 operating hours. The user may specify that the exchange be made earlier, depending upon the application process.
- Check the electrical and vacuum connections daily.

6.2 Maintenance Performed by the User

	WARNING !
<p>Only perform the work that is described here, and that which is permitted to be done by the user. All other maintenance and service work may only be performed by the manufacturer or a dealer authorized by him. Beware of the pump parts being possibly contaminated by hazardous substances. Wear protective clothing if there is contamination.</p>	

Scope of permissible work:

- Inspect the pump chambers, diaphragms and valves,
- Deposits in the inside of the pump must be cleaned out,
- Change the diaphragms, valves and seals.

	WARNING !
<p>Before opening the pump unplug it from the mains.</p>	

Tools required:

Tool kit: Order no. 402107, consists of:

- Order no. 826801-4 Cross-head screwdriver, size 2,
- Order no. 826801-2 Open spanner, size SW 14.

Maintenance and Servicing

6.2.1 Disassembly

1. Disconnect the power supply and ensure that it cannot be switched on again.
2. Open the cover of the casing.
3. Open the screw clamps of the hose bridge on the pump body with the open spanner, size 14.
4. Remove 2 x 4 screws **(1)** from each connecting head **(2)** with a cross-head screwdriver, size 2.
5. Lift off the connecting head **(2)** and the pump head **(5)**. The diaphragm is now freely exposed.
6. Loosen the defective diaphragm **(6)** by turning it anticlockwise.
7. Valves **(4)** and o-rings **(3)** are located between the connecting and the pump head. When dismantling both heads these parts are accessible.
8. Clean the valves **(4)**, o-rings **(3)** and diaphragm **(6)** with a soft cloth and acetone and replace defective items if necessary.

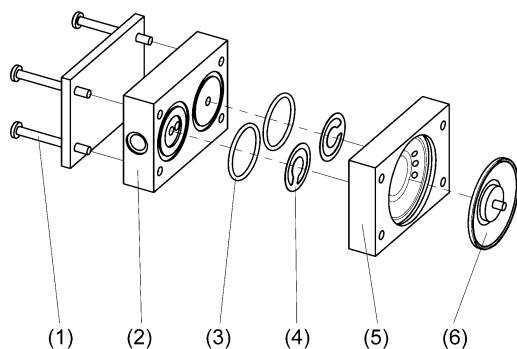



Fig. 3 Disassembly - Assembly

	WARNING !
Renew defective parts, if necessary! Wear protective gloves! Parts must be renewed at the intervals stated in this Operating Manual or as specified by the user internally! Do not clean with compressed air!	

6.2.2 Assembly (see Fig. 3)

1. Place the pump so that the diaphragm **(6)** is lying in a horizontal position.
2. Tighten the diaphragm **(6)** with the torque of 5 - 6 Nm.
3. Bring the connecting rod (see Fig. 4 - 6) and the diaphragm **(6)** into the central position.
4. Replace the pump head **(5)**.
5. Insert the valves **(4)** and the o-rings **(3)**. Ensure that they are lying completely flat. Do not insert the burred side facing the sealing surface.
6. Replace the connecting head **(2)** and tighten the 2 x 4 cross head screws **(1)** with a torque of 3 - 4 Nm.
7. Use an analog assembly sequence for all heads.
8. Reattach the hose connections with clamping ring screw fittings.
9. Close the casing by shutting the cover.

6.2.3 Test

- Connect the pump to the electrical supply.
- Connect a vacuum measuring device to the suction connector and measure the ultimate pressure.
If the device is working properly, then the figure stated in the technical data must be attained within a maximum of one minute.
- The pump must not make any abnormal noises.
- Moving parts must not touch each other.

6.3 Maintenance by the Manufacturer

Repairs and maintenance going beyond the extent of the work described *in chapter 6.2* or reconditioning or modification may only be performed by the manufacturer or authorized workshops.

	WARNING !
The user shall be liable for the consequences of an incorrect damage report or a contaminated pump. The statements in the damage report are legally binding.	

6.4 Damage Report

You find the form of the damage report to the Download on our web page in the menu "service" and "Downloads". www.welchvacuum.com
If you should not have an entrance to the Internet, you can request the form also gladly with us, under phone +49 3677 604 0.

	WARNING !
Incomplete or incorrectly completed damage reports may endanger the service personnel! Give full information in the damage report, in particular regarding a possible contaminating of the sensor.	

Troubleshooting

7 Troubleshooting

Only manufacturing firm and authorized service workshops may work on the diaphragm pump and their accessories during the warranty period.

Trouble	Cause	Remedy	
		by:	with:
Vacuum pump does not start	No power supply	Qualified electrician	Check electrical installation
	Motor defective	Service workshop	Exchange
	Pump body defective		Repair and/or exchange
Vacuum pump does not generate a vacuum or only an inadequate one	Connected apparatus and/or connecting elements leaking	User or Service workshop	Identify and seal the leak, replace the seals and/or hoses if necessary.
	Vacuum pump leaking		Check the hose connections between the pump heads, replace the hoses and/or fittings if necessary.
	Pump head leaking	Service workshop	Repair and/or exchange
	Diaphragm defective	User or Service workshop	Exchange of the diaphragm (see chapter 6.2)
	Valve defective		Exchange of the valve (see chapter 6.2)
	Vacuum pump dirty		General maintenance / cleaning
	Valves dirty		Cleaning condensates and foreign objects out of the valves.
Running noise	Vacuum pump dirty	User or Service workshop	General maintenance / cleaning
Glass components	defective and/or leaking	User	Exchange of the glass parts or seals
Cable(s)	defective and/or brittle	Qualified electrician	Exchange of the cable(s)

8 Spare Parts Overview

The spare parts lists contain all the spare parts and all the information necessary for ordering.

When ordering, please quote the description, quantity, serial number and order number!

	CAUTION !
We are not liable for any damage caused by the installation of any parts not supplied by the manufacturer.	

8.1 Service kit

Designation	Order no.
Service kit	402044

The service kit consists of:

Designation	Piece	Order no.
O-Ring ø 25 x 2	8	829250-1
O-Ring ø 8 x 2	7	829210-3
Formed diaphragm	4	828929-1
Valve	8	400656
Valve with hole	2	400656-4

Caution, the number of supplied construction units in the service kit corresponds to the maximum need of the series!

Spare Parts Overview

8.2 Spare parts view MPC 155 Z

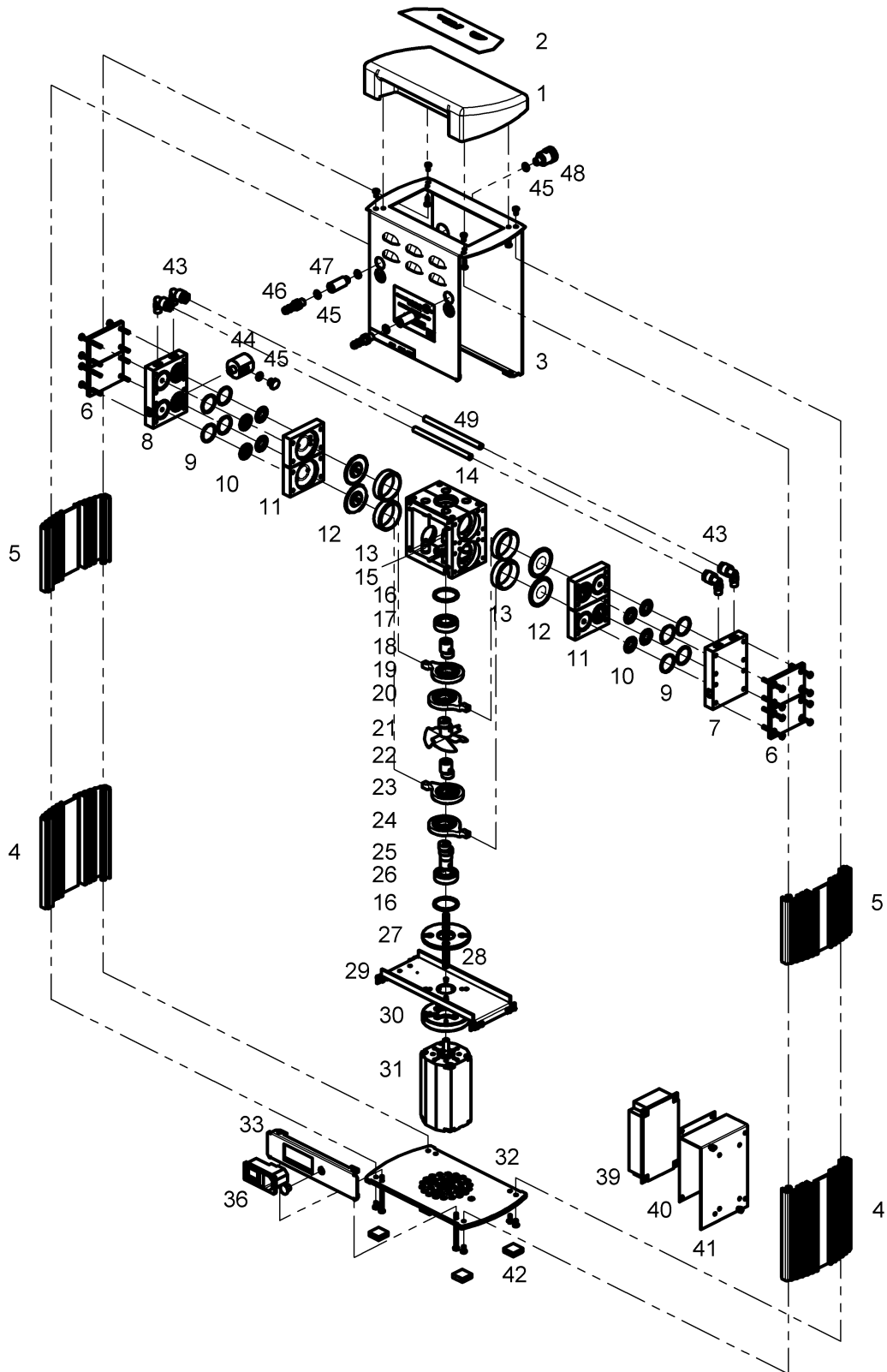

Fig. 4 Exploded view MPC 155 Z

8.3 Spare parts view MPC 105 T

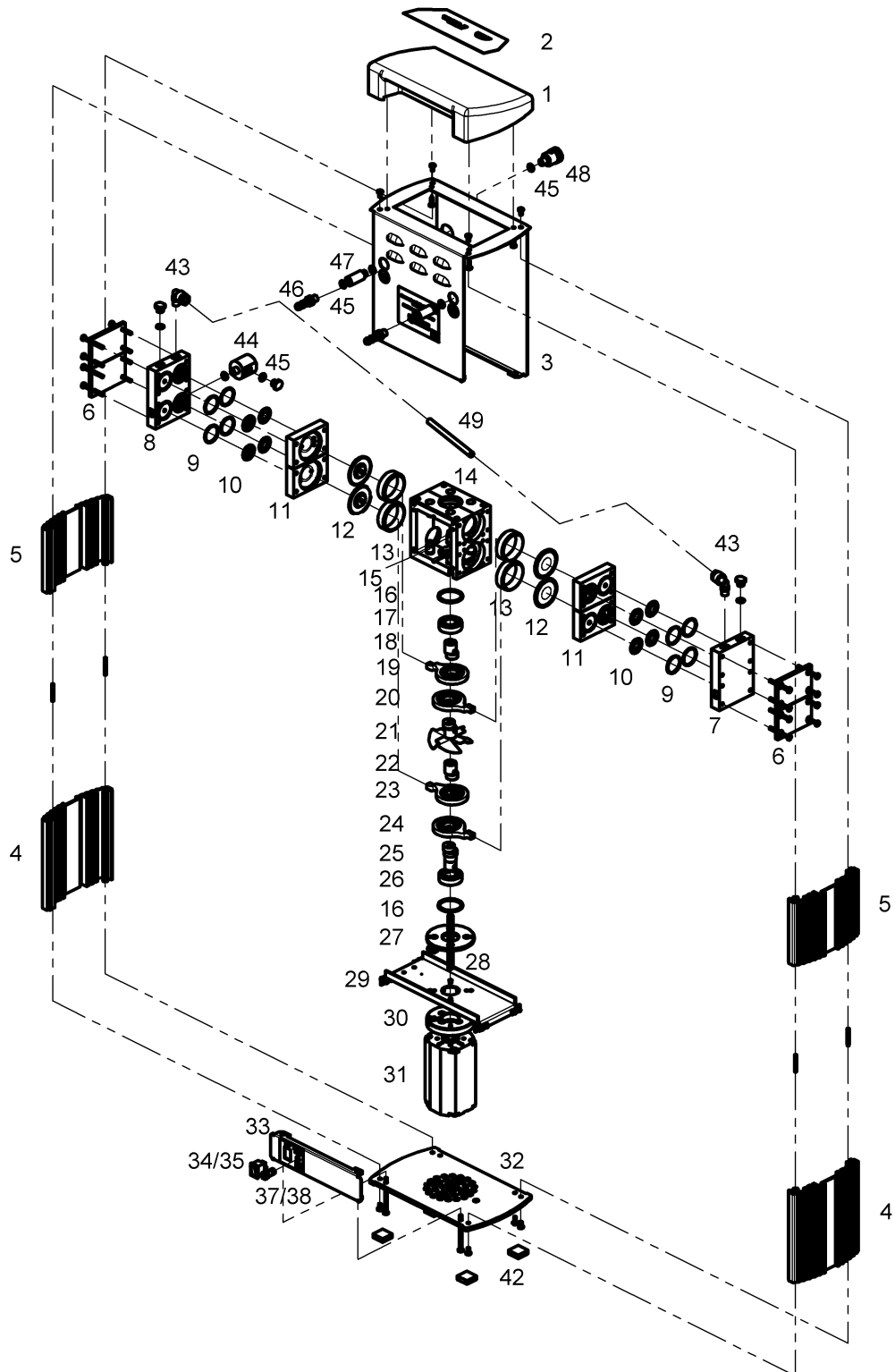

Fig. 5 Exploded view MPC 105 T

Spare Parts Overview

8.3.1 Spare parts list MPC 155 Z, MPC 105 T

Item no.	Designation	Piece	MPC 155 Z	MPC 105 T
			Order no. 412642	Order no. 412443-02
			Order no.	Order no.
1	Casing cover	1	410216	410216
2	Front foil	1	828906-03	828906-03
3	Casing	1	410213-06	410213-01
4	Aluminium-Profile L=155	2	400979	400979
5	Aluminium-Profile L=110	2	400979-12	400979-12
6	Pressure plate	4	400935	400935
7	Connection head - pressure side	1	400924-01	400924-01
8	Connection head - suction side	1	400924-02	400924-02
9	O-Ring EPDM Ø 25 x 2	8	829250-1	829250-1
10	Valve	8	400656	400656
11	Pump head	4	400898-02	400898-02
-	Basic pump complete (consisting of pos.: 12 – 31)	1	410202-05	410202-05
12	- Formed diaphragm	4	828929-1	828929-1
13	- Cylinder	4	400914	400914
14	- Pump casing	1	400913	400913
15	- Rubber element	4	400916	400916
16	- O-Ring EPDM Ø 32 x 3	2	829258	829258
-	Drive 1 complete (consisting of pos.: 17 – 19)	1	400919	400919
17	- Ball bearing	1	824963-1	824963-1
18	- Eccentric	1	400915	400915
19	- Piston rod with ball bearing	1	400892-01	400892-01
-	Drive 3 complete (consisting of pos.: 20 – 21)	1	400919-02	400919-02
20	- Piston rod with ball bearing	1	400892-01	400892-01
21	- Eccentric with fan wheel	1	400915-01	400915-01
-	Drive 2 complete (consisting of pos.: 22 – 23)	1	400919-01	400919-01
22	- Eccentric	1	400915	400915
23	- Piston rod with ball bearing	1	400892-01	400892-01
-	Drive 4.1 complete (consisting of pos.: 24 – 26)	1	400919-03	400919-03
24	- Piston rod with ball bearing	1	400892-01	400892-01
25	- Eccentric	1	400915-03	400915-03
26	- Ball bearing	1	824963-1	824963-1
27	- Insulating washer	1	400893-04	400893-04
28	- Shaft	1	400915-04	400915-04
29	- Intermediate plate	1	410215	410215
30	- Distance ring for motor	1	400923-01	400923-01
31	- Motor	1	400998-04	400998-04
32	Foot plate	1	410210	410210
33	Switch sheet metal	1	410214-02	410214-01
34	Rocker switch green	1	-	825186-3
35	Protective cap for rocker switch	1	-	825188-1
36	Combination connector	1	825274	-
37	Panel jack (Hollow plug)	1	-	825253
38	Power pack with hollow plug	1	-	827406
39	Power pack	1	827397-02	-
40	Insulating plate for power pack	1	113526-01	-
41	Adapter plate for power pack	1	400949-01	-
42	Casing foot	4	829112	829112
43	Threaded elbow joint PVDF, 8 – 1/8"	4	829936-1	-
		2	-	829936-1
44	Manifold PP, G1/8" – 1/8"	1	400921	400921
45	O-Ring EPDM Ø 8 x 2	6	829210-3	-
		9	-	829210-3
46	Hose nozzle PP, DN 8 – 1/8" (enclosed)	2	710797	710797
47	Extension	2	400779-5	400779-5
48	Gas ballast valve	1	400599-04	400599-04
49	Vacuum hose PTFE, 8/ 6 x 1 mm	0.4 m	828331	-
		0.2 m	-	828331
-	Mains connection cable IEC with plug CEE (D)	1	825885	825885
	Mains connection cable IEC with plug BS (UK)	1	825878	825878
	Mains connection cable IEC with plug NEMA 5-15 (US)	1	825903	825903

8.4 Spare parts view MPC 105 T iQ-P, MPC 105 T iQ (24V)

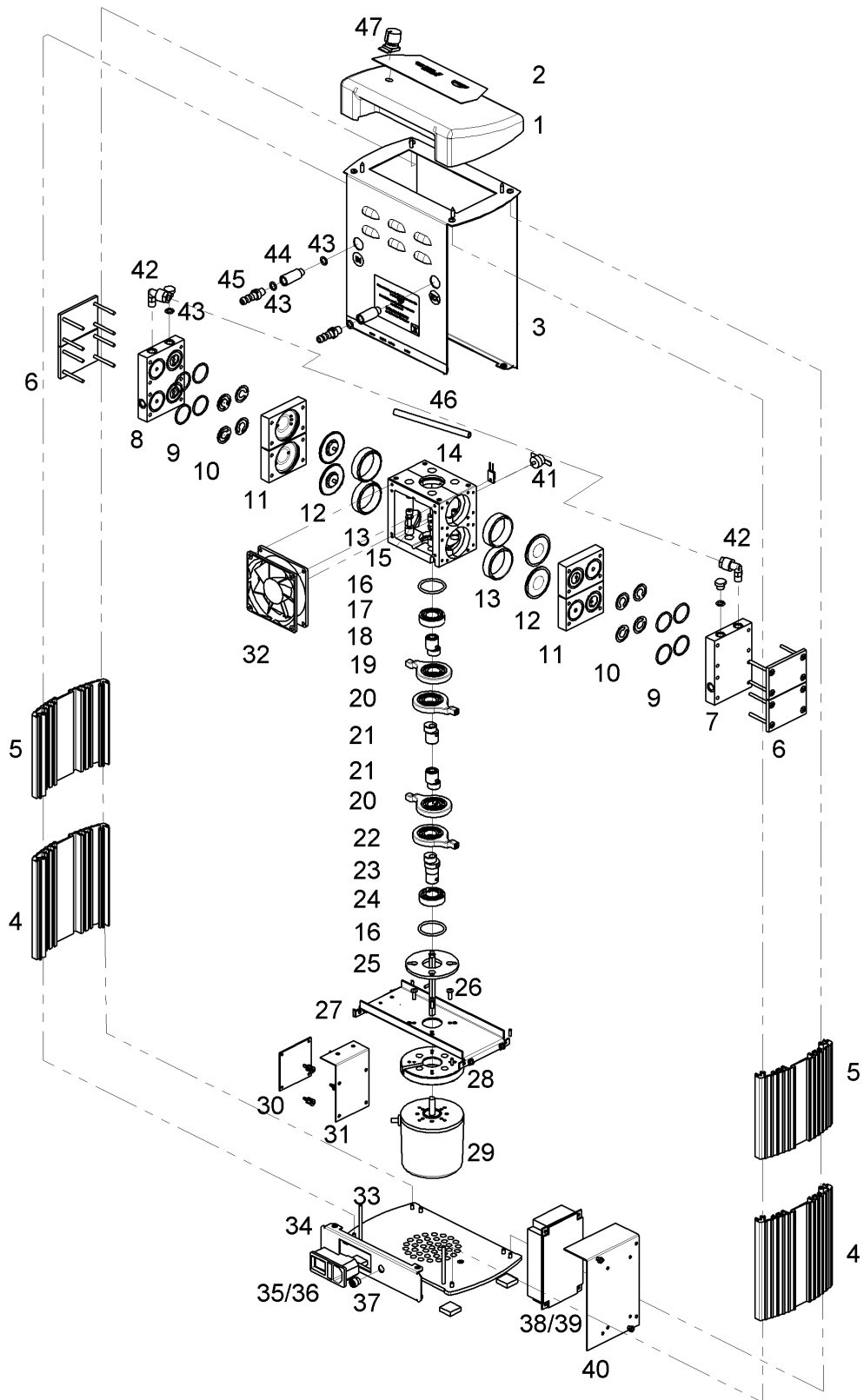

Fig. 6 Exploded view (MPC 105 T iQ-P)

Spare Parts Overview

8.4.1 Spare parts list MPC 105 T iQ-P, MPC 105 T iQ

Item no.	Designation	Piece	MPC 105 T iQ-P	MPC 105 T iQ
			Order no. 412443-15	Order no. 412443-17
			Order no.	Order no.
1	Casing cover	1	410216-01	410216
2	Front foil	1	828906-08	828906-03
3	Casing	1	410213-02	410213-02
4	Aluminium-Profile L=155	2	400979	400979
5	Aluminium-Profile L=128 mm	2	400979-04	400979-04
6	Pressure plate	4	400935	400935
7	Connection head - pressure side	1	400924-01	400924-01
8	Connection head - suction side	1	400924	400924
9	O-Ring EPDM Ø 25 x 2	8	829250-1	829250-1
10	Valve	6	400656	400656
	Valve with hole	2	400656-4	400656-4
11	Pump head	4	400898-02	400898-02
-	Basic pump complete <i>(consisting of position: 12 - 32)</i>	1	410202-10	410202-03
12	- Formed diaphragm	4	828929-1	828929-1
13	- Cylinder	4	400914	400914
14	- Pump casing	1	400913	400913
15	- Rubber element	4	400916	400916
16	- O-Ring EPDM Ø 32 x 3	2	829258	829258
-	- Drive 1 complete <i>(consisting of position: 17 - 19)</i>	2	400919	400919
17	- Ball bearing	1	824963-1	824963-1
18	- Eccentric	1	400915	400915
19	- Piston rod with ball bearing	1	400892-01	400892-01
-	- Drive 2 complete <i>(consisting of position: 20 - 21)</i>	1	400919-01	400919-01
20	- Piston rod with ball bearing	1	400892-01	400892-01
21	- Eccentric	1	400915	400915
-	- Drive 4.1 complete <i>(consisting of position: 22 - 24)</i>	1	400919-03	400919-03
22	- Piston rod with ball bearing	1	400892-01	400892-01
23	- Eccentric	1	400915-03	400915-03
24	- Ball bearing	1	824963-1	824963-1
25	- Insulating washer	1	400893-04	400893-04
26	- Shaft	1	400915-04	400915-04
27	- Intermediate plate	1	410215	410215
28	- Space ring for motor	1	400923	400923
29	- Motor	1	826393-1	826393-1
30	- Printed circuit board	1	825685-01	825685
31	- Adapter plate for printed circuit board	1	400949-04	400949-04
32	- DC Axial fan	1	829820-1	829820-1
33	Foot plate	1	410210	410210
34	Switch sheet metal	1	410214-02	410214-02
35	Combination connector	1	825274	825274
36	Fine-wire fuse T 6.3 A	1	825372	825372
37	Sub miniature round plug - flange box 710; 4 pole	1	825277-1	825277-1
38	Power pack	1	827397	827397
39	Insulating plate for power pack	1	113526	113526
40	Adapter plate for power pack	1	400949-01	400949-01
41	Thermal switch	1	825158	825158
42	Threaded elbow joint PVDF, 8 – 1/8"	2	829936-1	829936-1
43	O-Ring EPDM Ø 8 x 2	6	829210-3	829210-3
44	Hose nozzle PP, DN 8 – 1/8" <i>(enclosed)</i>	2	710797	710797
45	Extension	2	400779-5	400779-5
46	Vacuum hose PTFE, 8 / 6 x 1 mm	1 m	828331	828331
47	Potentiometer	1	825541	-
-	Mains connection cable IEC with plug CEE (D)	1	825885	825885

EG - Konformitätserklärung

EC Declaration of Conformity / CE Déclaration de Conformité

DIN EN ISO / IEC 17050

(de) Hiermit erklären wir	 by Gardner Denver	Gardner Denver Thomas GmbH Am Vogelherd 20 98693 Ilmenau Germany	T +49 3677 604 0 F +49 3677 604 131 welch.emea@gardnerdenver.com www.welchvacuum.com
unter eigener Verantwortung, dass nachstehendes Produkt aufgrund seiner Konzipierung und Bauart sowie in den von uns in Verkehr gebrachten Unterlagen den nachfolgend aufgeführten EG-Richtlinien und Normen entspricht. Bei einer nicht mit uns abgestimmten Änderung des Produkts verliert diese Erklärung ihre Gültigkeit.			
(en) We (Gardner Denver Thomas GmbH) herewith declare under our sole responsibility that the product described below is in accordance with the following Directives standards and other technical specifications regarding design and version when delivered from our factory. This declaration becomes invalid whenever the product has been modified without our consent.			
(fr) Nous (Gardner Denver Thomas GmbH) certifions par la présente, que le produit décrit ci-après est conforme, tant dans sa conception que dans sa réalisation, aux normes de sécurité et d'hygiène exigées par les standards de la CE. En cas de modification du produit sans notre accord, cette déclaration devient caduque.			

Bezeichnung des Produkts (Pumpen / Pumpstände) Description of product (pumps / pump systems) Description du produit (pompes / pompe systèmes)	Membranpumpen / Diaphragm pumps / Pompes à membrane MPC 155 Z, MPC 105 T, MPC 105 T iQ, MPC 105 T iQ-P
Artikel-Nr. / Fabrication No. / No. de fabrication	412642, 412443-02, 412443-17, 412443-15
Baujahr / Year of manufacture / Année de fabrication	2017

Das Produkt entspricht folgenden Richtlinien und Normen: / The product is in conformity with the following Directives and standards: / Le produit est conforme aux directives et standards suivants:		
X	2006/42/EG	Maschinenrichtlinie / EC machinery directive / directive CE sur les machines (17.05.2006)
	2014/34/EU	ATEX-Richtlinie für Verwendungen in explosionsgefährdeten Bereichen, Anhang III / ATEX Guideline for use in potentially explosive atmospheres, Appendix III / ATEX Directive for applications in hazardous areas, Annex III
X	2014/30/EU	Elektromagnetische Verträglichkeit / EC Electromagnetic Compatibility Directive / Directive CE relative à la compatibilité électromagnétique
X	2011/65/EU	Gefährliche Stoffe in Elektro- und Elektronikgeräten (RoHS II) / Dangerous materials in electrical and electronics devices (RoHS II) / Substances dangereuses dans les appareils électriques et électroniques (RoHS II)
X	2012/19/EU	Elektro- und Elektronik - Altgeräte (WEEE) / Electrical and electronics - old devices (WEEE) / Electro et électronique - appareils de contralto (WEEE)
X	China – RoHS II	Umweltschutzgesetz – China 2016-01 / Environment protection law / Loi sur la protection de environnement

Angewandte harmonisierte Normen: / Applied harmonized standards: / Standards appliqués et harmonisés:		
	DIN EN 1127-1: 2011-10	Explosionsfähige Atmosphären – Explosionsschutz - Teil 1: Grundlagen und Methodik / Explosive atmospheres - Explosion prevention and protection - part 1: Basic concepts and methodology / Atmosphères explosives - Protection contre les explosions - partie 1: prescriptions et méthodologie
	DIN EN 13463-1: 2009-07	Nicht-elektrische Geräte für den Einsatz in explosionsgefährdeten Bereichen - Teil 1: Grundlagen und Anforderungen / Non-electrical equipment for use in potentially explosive atmospheres - part 1: Basic method and requirements / Appareils non électriques destinés à être utilisés en atmosphères explosibles - partie 1: prescriptions et méthodologie
	DIN EN 13463-5: 2011-10	Nicht-elektrische Geräte für den Einsatz in explosionsgefährdeten Bereichen - Teil 5: Schutz durch konstruktive Sicherheit 'c' / Non-electrical equipment for use in potentially explosive atmospheres - part 5: Protection by constructional safety 'c' / Appareils non électriques destinés à être utilisés en atmosphères explosibles - partie 5: protection par sécurité de construction « c »
X	DIN EN ISO 12100: 2011-03	Sicherheit von Maschinen - Allgemeine Gestaltungsgrundsätze Risikobeurteilung und Risikominderung / Safety of machinery - General principles for design - Risk assessment and risk reduction / Sécurité des machines - / Principes généraux pour l'évaluation des risques et la réduction des risques
X	DIN EN ISO 13857: 2008-06	Sicherheit von Maschinen - Sicherheitsabstände gegen das Erreichen von Gefährdungsbereichen mit den oberen und unteren Gliedmaßen / Safety of machinery - Safety distances to prevent hazard zones being reached by upper and lower limbs / Sécurité des machines - Distances de sécurité empêchant les membres supérieurs et inférieurs d'atteindre les zones dangereuses
X	DIN EN 1012-2: 2011-12	Kompressoren und Vakuumpumpen - Sicherheitsanforderungen - Teil 2: Vakuumpumpen / Compressors and vacuum pumps - Safety requirements - part 2: Vacuum pumps / Compresseurs et pompes à vide - Exigences de sécurité - partie 2: pompes à vide
X	DIN EN ISO 2151: 2009-01	Akustik - Geräuschmessnorm für Kompressoren und Vakuumpumpen - Verfahren der Genauigkeitsklasse 2 / Acoustics - Noise test code for compressors and vacuum pumps – Engineering method (grade 2) / Acoustique - norme de mesure des émissions pour les compresseurs et les pompes à vide - Procédé de classe de précision 2
X	DIN EN 60204-1: 2014-10	Sicherheit von Maschinen - Elektrische Ausrüstung von Maschinen - Teil 1: Allgemeine Anforderungen / Safety of machinery - Electrical equipment of machines - part 1: General requirements / Sécurité des machines - Equipement électrique des machines - partie 1: Prescriptions générales
X	EN 61000-6-2: 2011-06	Elektromagnetische Verträglichkeit (EMV) - Teil 6-2: Fachgrundnormen - Störfestigkeit für Industriebereiche / Electromagnetic compatibility (EMC) - part 6-2: Generic standards - Immunity for industrial environments / Compatibilité électromagnétique (EMV) - partie 6-2: Normes génériques - Immunité pour les environnements industriels
X	EN 61000-6-4: 2011-09	Elektromagnetische Verträglichkeit (EMV) - Teil 6-4: Fachgrundnormen - Störaussendung für Industriebereiche / Electromagnetic compatibility (EMC) - part 6-4: Generic standards - Emission standard for industrial environments / Compatibilité électromagnétique - partie 6-4: Normes génériques - Emissions de parasites pour les activités industrielles
X	DIN EN 50110-1: 2014-02	Betrieb von elektrischen Anlagen / Operation of electrical installations / Fonctionnement des installations électriques
X	DIN EN 61010-1/A1:2015-04	Sicherheitsbestimmungen für elektrische Mess-, Steuer-, Regel- und Laborgeräte - Teil 1: Allgemeine Anforderungen / Safety requirements for electrical equipment for measurement, control and laboratory use - part 1: General requirements / Consignes de sécurité pour les appareils électriques de mesure, de commande, de régulation ou de laboratoire - partie 1: Prescriptions générales

Datum / Data	2017-02-17
Qualitätsbeauftragter / Quality representative / Délégué de qualité	Name / Name / Nom Gerd Reinhardt
Produktmanager / Product manager / Directeur de produit	Name / Name / Nom Oliver Fickert