



A Gardner Denver Product

**OWNER'S MANUAL
FOR
ASPIRATION / FILTRATION
VACUUM SYSTEM
MODELS:
2511 & 2515**



Approval Agency's

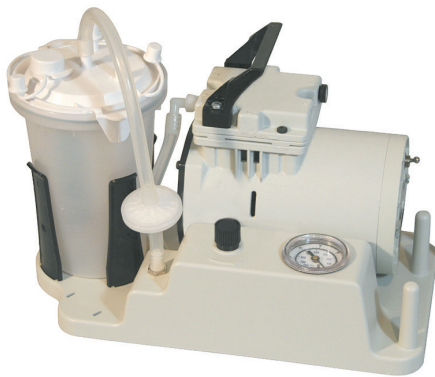

Model 2515B-75



Model 2515C-75 & 2515C-76



Warning
**Not recommended for pumping acid,
base or organic vapors or gases.**

Gardner Denver Welch Vacuum Technology, Inc.
5621 W. Howard Street
Niles, IL 60714
Phone: (847) 676-8800
Fax: (847) 677-8606 (Technical Support)
E-Mail: gdwelchvacuum@gardnerdenver.com
Web-Page: www.welchvacuum.com

For outside of U.S. and Canada, contact your local Gardner Denver sales office, see back page

Printed in USA
Part No. 642783

**INSTRUCTION
WARNING AND CAUTION
PLEASE READ BEFORE OPERATION**

While reading your manual, please pay close attention to areas labeled:

WARNING AND CAUTION.

The description of each is found below.

WARNING

Warnings are given where failure to observe instruction could result in injury or death to people.

CAUTION

Cautions are found where failure to observe the instruction could result in damage to the equipment, associated equipment and process.

These units confirm to the SI International system of units of measurement.

The following symbols (with recommendation of IEC1010) of warning will be found on the pump.



Caution - refer to accompanying documents



Caution - risk of electrical shock



Caution - hot surface



Double Insulated



OFF (Power)



ON (Power)

WARNING

Motor includes a self resetting thermal cutout and the pump could restart without actuation under fault condition.

TABLE OF CONTENTS

Section 01 - SAFETY INFORMATION

- 1.10 Caution To Prevent Injury
- 1.20 Caution To Reduce Risk Of Electrical Shock
- 1.30 Warning To Reduce Risk Of Electrocution
- 1.40 Danger To Reduce Risk Of Explosion Or Fire

Section 02 - INSTALLATION

- 2.10 Introduction
- 2.20 Unpacking
- 2.30 Pump Mounting
- 2.40 Pump Location
- 2.50 Intake And Discharge Provision
- 2.60 Electrical Power
- 2.70 Vacuum Connection
- 2.80 Vacuum Gauges
- 2.90 Traps

Section 03 - OPERATION

- 3.10 Starting Procedures
- 3.20 Leak Detection
- 3.30 Operating Pressure Range
- 3.40 Shutdown Procedures

Section 04 - MAINTENANCE

- 4.10 Maintenance Procedures

Section 05 - TROUBLESHOOTING

- 5.10 Vacuum Problems
- 5.20 Pressure Problems
- 5.30 Trouble Shooting Guide For 2515

Section 06 - SPECIFICATION

- 6.10 Specification Table

Section 07 - WARRANTY

Section 08 - EXPLODED VIEWS AND PARTS LIST

- 8.10 Exploded View And Parts List For 2515B-75 / 2515C-75 / 2515C-76
- 8.11 Exploded View And Parts List For 1475K-20

Section 09 - KITS AND ACCESSORIES

SECTION 1: SAFETY INFORMATION

1.10 Caution: To Prevent Injury...

- 1.11 Never operate this product if it has a damaged cord or plug. If it is not working properly, has been dropped, damaged or has fallen into water, please return the product to a Welch service center for examination and repair.
- 1.12 Keep the cord away from heated surfaces. All electrical products generate heat. To avoid serious burns never touch unit during or immediately after operation.
- 1.13 Never block any air openings or place it on a soft surface where the openings may be blocked. The air openings are for ventilation of the motor inside the housing. Keep all air openings free of lint, dirt and other foreign objects.
- 1.14 Models 2511 and 2515 are thermally protected and can automatically restart when the protector resets. Always disconnect power source before servicing.
- 1.15 Never drop or insert fingers or any other object into any openings.
- 1.16 Do not operate this product where oxygen is being administered.
- 1.17 Wear safety glasses and goggles when operating this product. Never point any air nozzle or air sprayer toward another person or any part of the body.
- 1.18 Use only in well ventilated areas.
- 1.19 Do not use any tools or attachments without first determining maximum air pressure for that tool or attachment (applies to model 2511 only). Be sure to properly identify intake and discharge before using pump. See Section 2.50.



WARNING
Do not fill the collection jar above the safe fill level line indicated on the jar.

1.20 Caution: To Reduce Risk Of Electrical Shock...

- 1.21 Do not disassemble. Disassembly or attempted repairs if accomplished incorrectly can create electrical shock hazard. Refer servicing to qualified service agencies only.
- 1.22 115V unit is supplied with a three pronged plug.
Be sure to connect pump to a properly grounded outlet only.

1.30 Warning: To Reduce Risk Of Electrocutation...

- 1.31 Do not use this product in or near area where it can fall or be pulled into water or other liquids.
- 1.32 Do not reach for this product if it has fallen into liquid. Unplug immediately.
- 1.33 Never operate this product outdoors in the rain or in a wet area.

1.40 Danger: To Reduce Risk Of Explosion or Fire...

- 1.41 Do not use this pump in or near explosive atmospheres or where aerosol (spray) products are being used.
- 1.42 Do not pump anything other than atmospheric air.
- 1.43 Do not pump combustible liquids or vapors with this product or use in or near an area where flammable or explosive liquids or vapors may exist.
- 1.44 Do not use this product near flames.



WARNING
Failure to observe the above safety precautions could result in severe bodily injury, including death in extreme cases.

SECTION 2: INSTALLATION

2.10 Introduction

2.11 This manual has been compiled not only for the care and maintenance of the Welch Aspiration/Filtration Vacuum System now in your possession, but as a helpful reference and guide to prevent many problems which may occur if used improperly.

2.20 Unpacking

2.21 Carefully remove the Aspiration/Filtration Vacuum System from the shipping case. Preserve all paperwork for future reference. If damage has occurred from shipment a claim must be filed with the carrier immediately; preserve the shipping carton for inspection by the carrier. If you are required to communicate with your dealer or Welch Vacuum, be sure to include your order numbers for quick identification. Do not return the pump to the factory without first calling for a returned goods number.

2.30 Pump Mounting

2.31 Rubber feet are attached to the pump. Rubber feet are excellent for applications involving a semi-flexible surface such as a bench top; they help to isolate noise and eliminate creeping. All Aspiration/Filtration Vacuum Systems should be mounted on a horizontal plane.

2.40 Pump Location

2.41 The Aspiration/Filtration Vacuum System should be located preferably in a clean, dry, and well ventilated area. Please be sure not to block the ventilation holes located on the motor housing. The system should be placed where the surrounding temperature remains between 10°C and 40°C (50°F and 104°F). Always check to insure the location chosen is protected from direct or indirect moisture contact. Welch recommends that the pump be installed at the highest point within the system to prevent possible water condensate from entering the pump. The pump should be located as closely to its system in order to utilize it most efficiently.



WARNING

The motor is thermally protected and will automatically restart unexpectedly when the overload device resets. Don't pump flammable or explosive gases or vapors or operate this pump in an atmosphere containing flammable or explosive gases or vapors.

2.50 Intake And Discharge Provision

2.51 The vacuum regulator and vacuum dial gauge is attached to the collection jar. The vacuum regulator allows the vacuum level to be set between roughly atmospheric pressure and the maximum vacuum allowed for the pump model. The collection jar and hydrophobic filter keeps water from accidentally being drawn into the unit. The regulator allows discharge pressure to be set between atmospheric and the maximum possible for the pump model. Model 2511 is equipped with a pressure port.

Note: Adjusting the vacuum regulators will affect the performance of the pump.

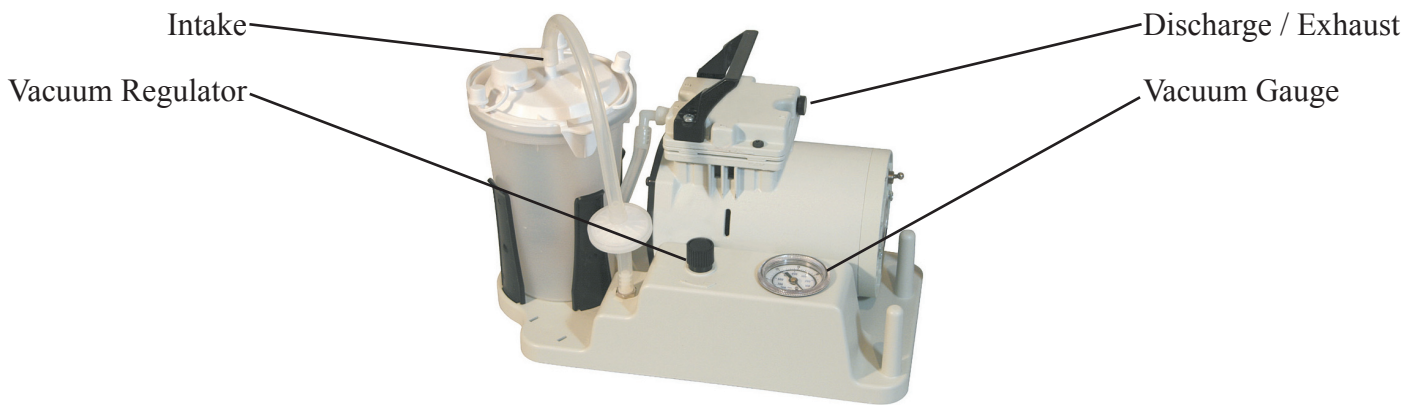

Model 2515B-75



Model 2515C-75



WARNING
Never block the discharge port. If the exhaust is blocked, pressure will build-up in the pump above its rated operating pressure.

Be sure to call Welch technical service prior to start up at 847-676-8800 if you have any questions.

2.60 Electrical Power

2.61 Power Source Review

Review the power source and the motor rating to be sure they agree in voltage, phase, and frequency. Serious damage may occur to the motor if it is connected to an improper voltage. All Welch pumps must be grounded. Grounding reduces the risk of electric shock in the event of an electrical short circuit. The plug must be plugged into a properly grounded outlet. Consult your local electrical codes if you have doubts.

2.62 Overload Protection (Model 2515)

Motor thermal overload protection is made available by the motor manufacturer as an aid to minimize motor failure. Overload protection is a standard feature on both 50 and 60 Hz single-phase-motors. The motors have automatic overload protection. Automatic reset protection is designed to reset itself after a predetermined cooling period. If the fault to the drive remains unaltered, the motor will cycle on and off until the fault is corrected.

2.63 Classification And Symbol Glossary

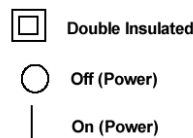

2.70 Vacuum Connection

2.71 For best results, Welch recommends the length of the tubing between the pump and the chamber be kept as small as possible.

2.80 Vacuum Gauges

2.81 All Aspiration/Filtration Vacuum Systems come with dial vacuum gauges. The vacuum gauge gives negative pressure - That is pressure below atmospheric. The reference point for the gauge is atmospheric pressure.

2.90 Traps

2.91 The need for a Trap

The pumps will handle humid air. All wetted aluminum parts are treated for corrosion protection from moisture. All other wetted parts are stainless steel. A plastic trap with a float valve is attached to the regulator assembly to prevent water condensate from accidentally being ingested into the pump. See figure below.

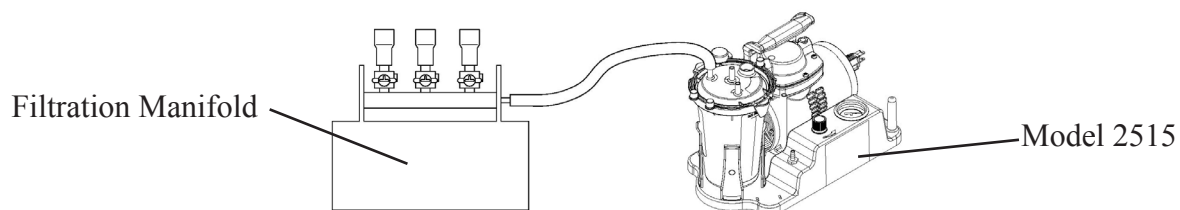

WARNING

The pump is not recommended for pumping acid, base or organic vapors or gases. Serious damage to the pump will shorten the pump's service life. In addition, pumping flammable vapors or gases can lead to serious safety hazard leading to fire or explosion.



SECTION 3: OPERATION

3.10 Starting Procedures

3.11 Starting a Welch Aspiration/Filtration Vacuum System

Before attaching the pump to a system, familiarize yourself with the function and action of the Aspiration/Filtration Vacuum System that you have acquired. Review the power requirements as described in Section 2.60. Welch recommends running the pump for a few minutes to warm it up, before use. The warm-up improves the pumps ability to handle humid air. Set the device on a level, sturdy surface so the controls can be easily reached and adjusted. Connect one end of the application tubing to the lid vacuum port.

Note: The in-line hydrophobic filter is designed to prevent foreign material from being drawn into the device. Pump performance may decrease if the hydrophobic filter gets wet or build up of foreign material or Medfilter occurs. It may be necessary to periodically change the hydrophobic filter



CAUTION
Do not move this device with a full collection jar.

1. Be sure that the power switch is in the OFF (down) position. Plug in the device and turn the switch to the ON (up) position.
2. Block the application tube leading from the collection jar and allow the gauge to reach stable vacuum level.
3. Set vacuum level by turning the regulator knob counter-clockwise to increase vacuum or clockwise to decrease vacuum..

Note: This procedure should be performed each time you use this device.

3.12 Cleaning The Device

1. Make sure the ON/OFF switch is in the OFF (down) position.
2. Unplug the device from the wall outlet and allow suction level to drop.
3. Remove the application tube from the lid vacuum port. Tubing should be cleaned after every use. Run hot water through it. Soak in a solution of one part of vinegar to three parts hot water for 20 minutes. Rinse with hot tap water and air dry.
4. Remove the pump tubing from the top of the jar lid.
5. Remove the jar from the holder and place on a firm, flat surface. Release the tabs and lift the lid from the jar.
6. Wash the jar, gasket, lid and tube in a hot water/dishwashing detergent solution and rinse with hot tap water. Soak in a solution of one part of vinegar to three parts hot water for 20 minutes. Rinse with hot tap water and air dry.
7. Wipe the outside of the case with a clean, damp cloth after each use.

3.20 Leak Detection

3.21 The importance of eliminating all leaks in a vacuum system is obvious. The pump must remove this added volume of leaked gas to maintain the desired vacuum. Leaks for these pumps can be located by slightly pressuring the system and painting the suspected area with a thick soap solution. Escaping air will produce soap bubbles.

3.30 Operating Pressure Range

3.31 Aspiration/Filtration Vacuum Systems are designed to be run from slightly below atmospheric to their maximum vacuum level on the intake side. Consult the Specification Table for the ratings of your specific model (See Section 6, Specifications).

3.40 Shutdown Procedures

3.41 After use, Welch recommends the pump be run for about 2 minutes disconnected from the vacuum process. The air pumped through the mechanism will purge out water vapor or droplets of water condensate that may have formed on the inside of the pump. This purge of the pump mechanism helps prevent corrosion.

SECTION 4: MAINTENANCE

4.10 Maintenance Procedures

4.11 Maintaining a Welch Aspiration/Filtration Vacuum System

These units are 100% oil-free. The pump employs a non-lube piston and cylinder. No maintenance is necessary for the bearings. All bearings are sealed and permanently lubricated. Lubrication should not be attempted. The units are built for continuous duty operation with the quietness and durability of a diaphragm, but with piston performance.

4.12 Hydrophobic Filter Replacement

Change the filter whenever foreign material is drawn into it or if you notice a reduction in vacuum level.

1. Disconnect the long tube from the fitting on top of the jar lid.
2. Gently pull the hydrophobic filter off of the short tube, that is connected to the regulator inlet port, and then remove the long tube from the hydrophobic filter .
3. With the green dot facing down, push the new hydrophobic filter into the short tube, that is connected to the regulator inlet port, then push the long tube.
4. Connect the long tube to the green dot facing barb, and then connect to the fitting on top of the jar lid.

SECTION 5: TROUBLESHOOTING

5.10 VACUUM PROBLEMS

5.11 Leakage, contamination, and unusual outgassing are the general causes of problems associated with poor vacuum. To operate at maximum efficiency, a system must be thoroughly clean. If the system is completely clean and free from leaks and unwarranted vacuum problems still exist, the pump should be checked. A simple criterion for the condition of the pump is the determination of its maximum vacuum capability. This can be accomplished by blocking of the intake and reading the vacuum level on the gauge (See Section 2.80).

5.20 PRESSURE PROBLEMS

5.21 Leakage and contamination are the general causes of problems associated with poor pressure. To operate at maximum efficiency a system must be thoroughly clean. If the system is completely clean and free from leaks and unwarranted pressure problems still exist, the pump/compressor should be checked by a service technician.

5.30 TROUBLE SHOOTING GUIDE FOR 2515

Poor Pumping Speed	Poor Vacuum	Loud Unit	Possible Cause	Corrective Action
X	X	X	Damaged Valves	Replace flapper Valves
X	X	X	Debris in Valves	Remove debris and check for valve damage
X	X	X	Damaged Gasket	Replace Gasket
X	X	X	Loose Head Screw	Tighten Head Screw
X	X	X	Loose Fitting	Tighten Fitting

Trouble Shooting Guide continued on next page.

5.40 TROUBLE SHOOTING GUIDE FOR 2515 MODELS

Symptoms	Possible Cause	Remedies
Reduced/low vacuum	<ol style="list-style-type: none"> 1. Clogged hydrophobic filter. 2. Regulator improperly set. 3. Air leak. 4. Jar lid gasket not secured to jar. 	<ol style="list-style-type: none"> 1. Replace the filter following directions in this manual. (Section 4.12) 2. Set regulator vacuum level following operating instructions. 3. Check the tubing and connectors for possible leaks. Attach, tighten or replace. 4. Be sure the jar lid and gasket fit tightly on the jar.
Device does not start	<ol style="list-style-type: none"> 1. Power cord not plugged in. 2. Defective switch. 3. Vacuum still exists in system. 	<ol style="list-style-type: none"> 1. Plug in the power cord. 2. Contact your service center or distributor. (See back page) 3. Disconnect tubing from the collection jar to release vacuum. Reconnect tubing and turn on the device.
Gauge reads incorrectly	<ol style="list-style-type: none"> 1. Faulty gauge. 	<ol style="list-style-type: none"> 1. Contact your service center for repair (410) 712-4100.
Device runs but gauge reads zero	<ol style="list-style-type: none"> 1. Gauge tubing not connected or is leaking. 	<ol style="list-style-type: none"> 1. Check the tubing and connectors for possible leaks. Attach, tighten or replace.
Device stops running during use	<ol style="list-style-type: none"> 1. Device overheated. 2. Blown fuse or circuit breaker in household circuit. 3. Low voltage to device. 	<ol style="list-style-type: none"> 1. Unplug device and allow to cool for 10 minutes. Plug in and restart. 2. Replace fuse or reset breaker. 3. Too many motor operated appliances on same circuit.

SECTION 6: SPECIFICATION

6.10 SPECIFICATION TABLE

Model 2515			
Catalog No.	2515B-75	2515C-75	2515C-76
Free Air Displacement CFM (L/min)	1.2 (34)	1.0 (28)	1.2 (34)
Maximum Vacuum	27.2 in. Hg		
Ultimate Vacuum	70 Torr (93 mbar)		
Dimensions L x W x H in. (cm)	14.8 x 8.3 x 10 Inches (37.5 x 21 x 25.5 cm)		
Shipping Weight	19 lbs		
Electrical Requirements	115V, 60Hz	230V, 50Hz	100V, 50/60Hz

SECTION 7: WARRANTY

IMPORTANT
Please Read Carefully Before Operating
This Welch® Vacuum Pump

UNPACKING

Inspect the pump carefully. If any damage has occurred, immediately file claim with the carrier immediately. Save the shipping container for carrier to inspect.

OPERATING PUMP

Refer to the enclosed Instruction/Operation Manual for all information to properly operate and maintain the pump.

WARRANTY

This Welch Vacuum product is warranted to be free from defects in material and workmanship. The liability of Gardner Denver Welch Vacuum Technology under this warranty is limited to servicing, adjusting, repairing or replacing any unit or component part which in the judgment of Gardner Denver Welch Vacuum Technology has not been misused, abused or altered in any way causing impaired performance or rendering it inoperative. No other warranties are expressed or implied. The method of executing this warranty: servicing, adjusting, repairing or replacing shall be at the discretion of Gardner Denver Welch Vacuum Technology. Vacuum pumps that have been used for any period, however short, will be repaired under this warranty rather than replaced.

The warranty is effective for one year from the date of original purchase when:

1. The warranty card has been completed and returned.
2. The product is returned to the factory or other designated service centers, freight prepaid.
3. The product in our judgment is defective through no action or fault of the user.

If the product has become defective through misuse, abuse, or alteration, repairs will be billed regardless of the age of the product. In this event, an estimate of the repair costs will be submitted and authorization of these charges will be required before the product is repaired and returned.

To reduce additional charges and delays either within or outside of the warranty period, contact Gardner Denver Welch Vacuum Technology @410-712-4100 for a return authorization number. Products without a return authorization number will be refused by our receiving department. Before shipping, properly pack the pump, insure it against loss or damage, and on the outside of the pump packaging and the packing slip write in the return authorization number. Pumps damaged due to improper packaging are the customer's responsibility.

8.11 Model 2515B-75 / 2515C-75 / 2515C-76

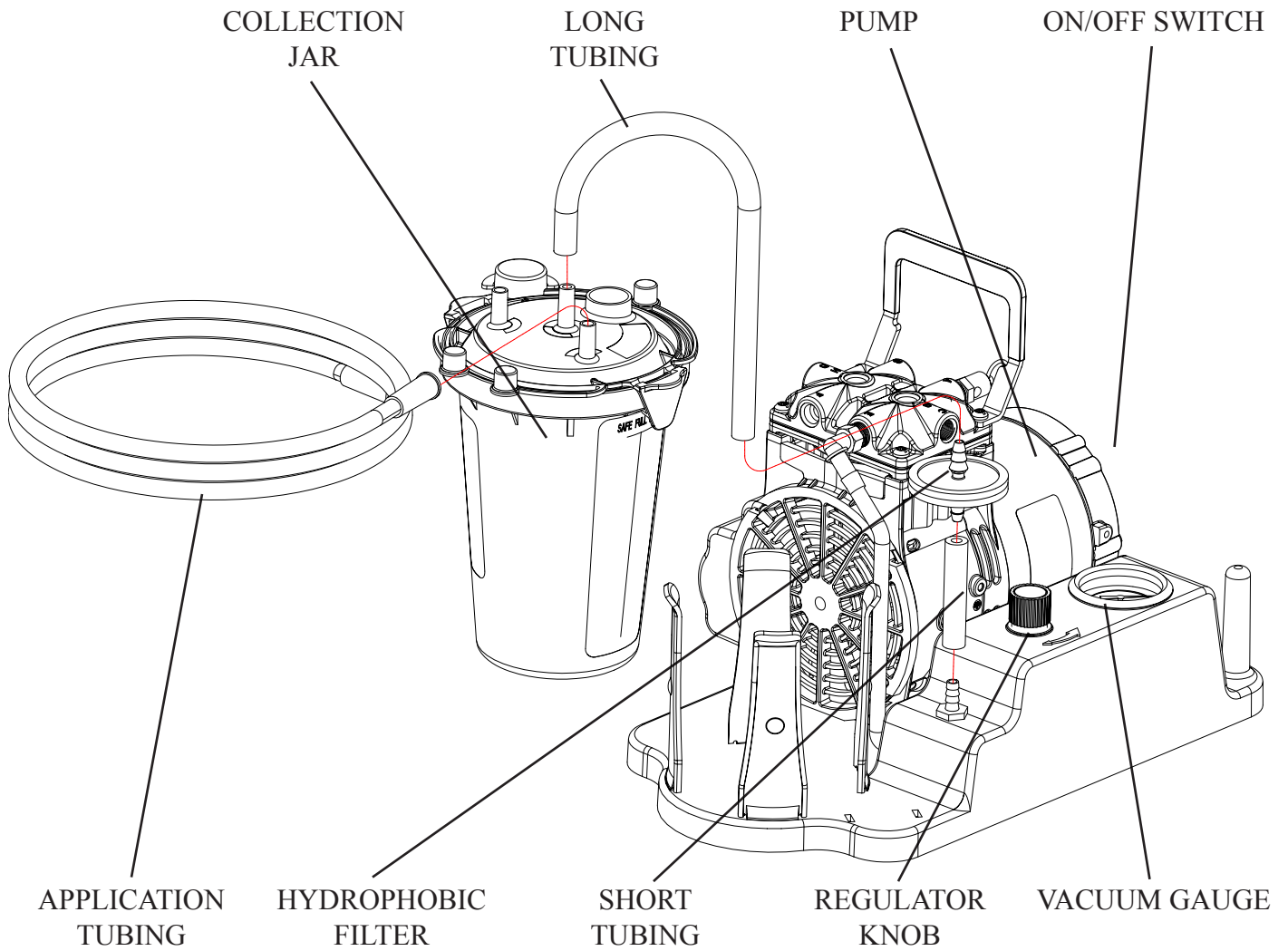

8.12 Model 1475K-20

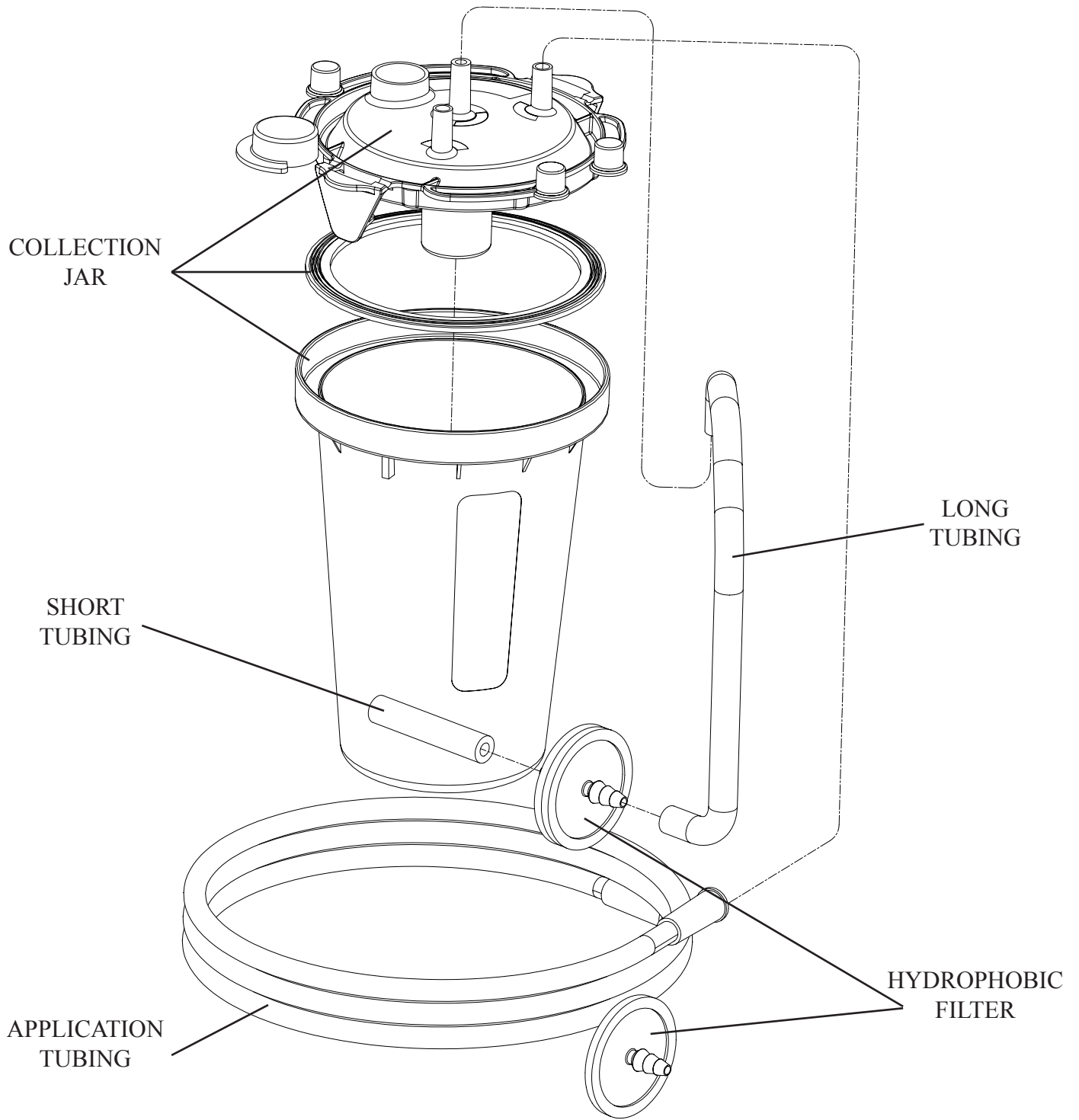

SECTION 9: KITS AND ACCESSORIES

9.10 REPAIR KITS



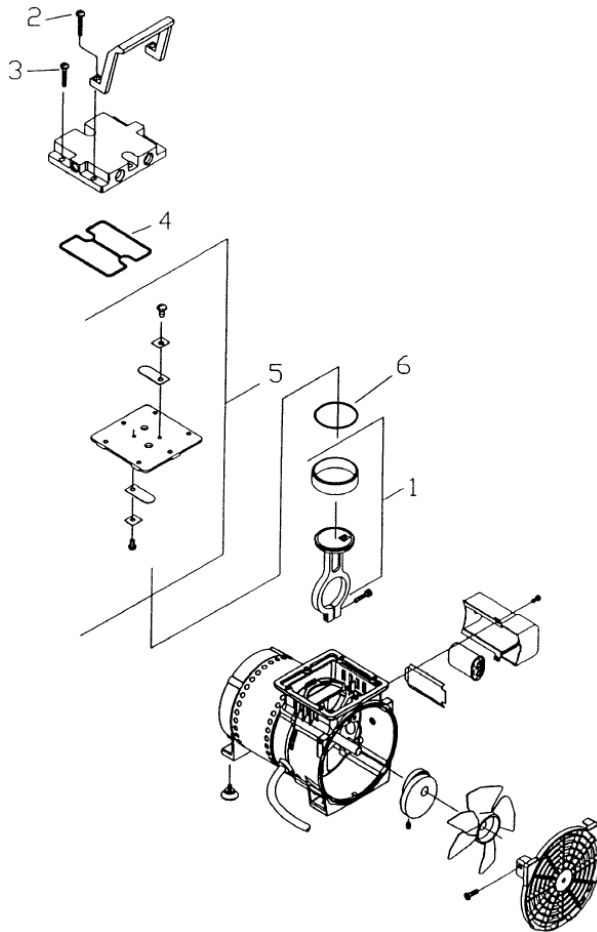





9.11 Repair Kit for Model 2515

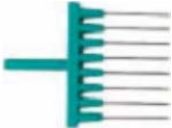

Description	Service Kit 2515K-01	Seal Gasket Kit 2515K-02
Connecting Rod Assembly #1	1	-
Handle Screw #2	2	-
Head Screw #3	4	-
Head O-Ring #4	1	1
Valve Plate Assembly #5	1	-
Cylinder O-Ring #6	1	1

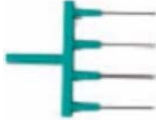
9.20 VACUUM ACCESSORIES

9.21 Table for Vacuum Accessories

Description	Welch Kit
Adapter S.S. 40mm 	1475K-01
8-Channel Adapter S.S. 40mm 	1475K-02
1-Channel Adapter for disposable tips, w/o ejector 	1475K-03
Rubber Adapter for Pasteur pipettes 	1475K-04
8-Channel Adapter for disposable tips, w/ejector 	1475K-05
Adapter S.S. 150mm 	1475K-06
4-Channel Adapter S.S. 40mm 	1475K-07
Adapter S.S. 280mm 	1475K-08
1-Channel Adapter for disposable tips, w/ejector 	1475K-09
Vacuboy Hand Operator w/ 1-Channel Adapter S.S. 	1475K-10

9.30 ELECTRICAL ACCESSORIES

9.31 Table for Electrical Accessories

Description	Welch Kit
115V 60Hz - Maintained on/off footswitch 	1430A
115V 60Hz - Variable on/off footswitch 	1430B
90-230V 50/60Hz - Variable on/off footswitch with IEC connections 	1430C

9.40 REPLACEMENT ACCESSORIES

9.41 Table for Replacement Accessories

Description	Welch Kit
Aspiration Kit - Includes: 6 ft tubing, 2000ml Autoclavable jar w/lid, and two hydrophobic filters 	1475K-20
ten hydrophobic filters 	1475K-21

Gardner Denver Welch Vacuum Technology, Inc.
5621 W. Howard Street
Niles, IL 60714
Phone: (847) 676-8800
Fax: (847) 677-8606 (Technical Support)
E-Mail: gdwelchvacuum@gardnerdenver.com
Web-Page: www.welchvacuum.com

Copyright© 1997-2007 Gardner Denver Welch Vacuum Technology,
Welch is a registered trademark of Gardner Denver Thomas, Inc.